



EP4-1

MULTI FUNCTION DIGITAL VOLTAGE RELAY

User's Manual

RESTRICTIONS ON USE

When using this product in applications that require particular safety or when using this product in important facilities, please pay attention to the safety of the overall system and equipment. Install fail-safe mechanisms, perform redundancy checks and periodic inspections and adopt other appropriate safety measures when it is necessary. This product is rated at Class II .

SAFETY PRECAUTION

- This manual uses the following symbols to ensure safe operation of this product.
- WARNING** Warnings are indicated when mishandling this product might result in death or serious injury to user.
 - CAUTION** Cautions are indicated when mishandling this product might result in minor injury to the user, or only physical damage to the timer.

WARNING

- Note this incorrect wiring of this product can damage it and lead to other hazards. Make sure the product has been correctly wired before turning the power ON.
- Before wiring, or removing / mounting the product, be sure to turn the power OFF. Failure to do so might cause electric shock.
- Do not touch electrically charged parts such as the power terminals. Doing so might cause electric shock.
- Do not disassemble the product. Doing so might cause electric shock or faulty operation.

CAUTION

- Use the product within the operating ranges recommended in the specification (temperature, humidity, voltage, shock, mounting direction, atmosphere and etc.). Failure to do so might cause fire or faulty operation.
- Firmly tighten the wires to the terminal. Insufficient tightening of the wires to the terminal might cause fire.

SPECIFICATIONS

Operating voltage	AC/DC : 100 - 240V, DC : 8 - 60V(for EP4-11060- only)
Allowable operating voltage range	85 ~ 110% of rated operating voltage
Rated frequency	50 / 60 Hz
Contact rating	250VAC 5A (Resistive load)
Display error	±1%(at 550V)
Power consumption	Approx. 3.3VA
Life	Mechanical : 5,000,000 times / Electrical : 100,000 times
Ambient temperature	-10 ~ +50 °C (without condensation & freezing)
Ambient humidity	MAX 85% RH (without condensation)
Altitude	MAX 2000m
Weight	Approx. 130g

NAMES AND FUNCTIONS OF FACEPLATE

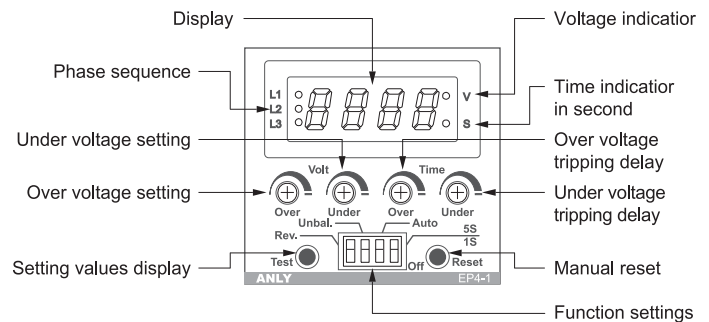

SETTING PROCEDURE

1. Over voltage setting



Set the desired value for over voltage. The display will show existing 3-phase voltages after 10 seconds.

3. Over voltage tripping delay setting



Set the tripping delay for over voltage. The display will show existing 3-phase voltages after 10 seconds.

2. Under voltage setting



Set the desired value for under voltage. The display will show existing 3-phase voltages after 10 seconds.

4. Under voltage tripping delay setting



Set the tripping delay for under voltage. The display will show existing 3-phase voltages after 10 seconds.

5. DIP switches setting



REV.	ON	Phase reversal protection ON
	OFF	Phase reversal protection OFF
UNBAL.	ON	Unbalance protection ON
	OFF	Unbalance protection OFF
AUTO	ON	Auto reset
	OFF	Manual reset
5S/1S	ON	Auto reset delay 5 sec
	OFF	Auto reset delay 1 sec

6. Setting display

Pressing "TEST" will cycle-through all settings in sequence. 3-phase voltages are displayed after 10-second of idle.

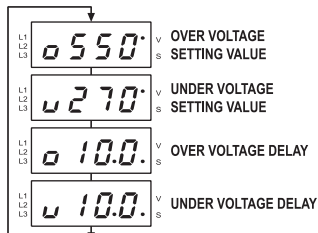

DISPLAY

1. 3-phase voltages display

Phase-to-phase voltages are displayed in sequence.

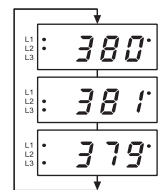

2. Fault indications

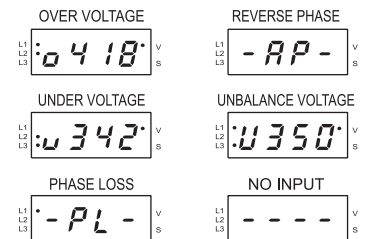

DIMENSIONS

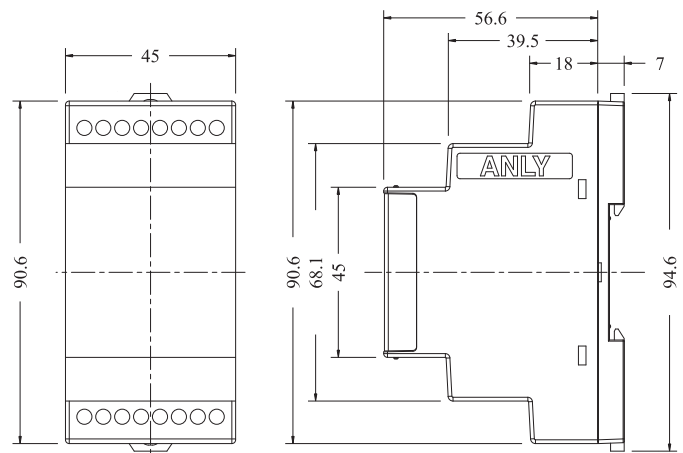

CONNECTION

DC Voltage(8-60V)

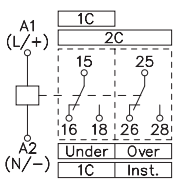

DC Voltage

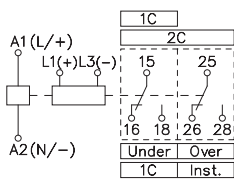

1-Phase 2-Wire

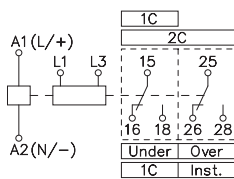

3-Phase 3-Wire

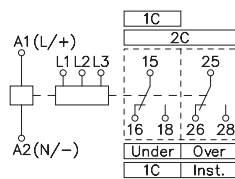

3-Phase 4-Wire

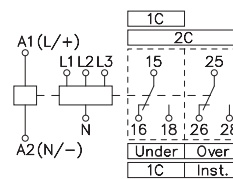

TYPE SELECTION

Voltage type		DC Type	Single Phase	3 Phase 3 Wire	3 Phase 4 Wire
		EP4-11----	EP4-12----	EP4-13----	EP4-14----
Voltage detect range	8~60VDC	EP4-11060-	-	-	-
	50~200VDC	EP4-11200-	-	-	-
	70~150V	EP4-11150-	EP4-12150-	EP4-13150-	-
	160~300V	EP4-11300-	EP4-12300-	EP4-13300-	EP4-14300-
	270~550V	-	EP4-12550-	EP4-13550-	EP4-14550-

Output contact	1C No-Fault	1C Fault	2C Over & Under Fault
	EP4-1----1	EP4-1----2	EP4-1----3
	2C Inst.&No-Fault	2C No-Fault	2C Over&Under
	EP4-1----4	EP4-1----5	EP4-1----6

TIMING CHART

