



ANLY CONTROLLER

AEVR MULTI-FUNCTIONABLE DIGITAL VOLTAGE CONTROLLER



CHARACTERISTIC :

- Digital 3-phase voltage indicator and fault detector
- Over voltage detection - 0.1sec~10sec adjustable tripping delay
- Under voltage detection - 0.1sec~10sec adjustable tripping delay
- Phase-loss detection - 2sec fixed tripping delay
- Phase sequence detection - 0.5sec fixed tripping delay
- 3-phase voltage balance($\pm 5\%$) detection - 3sec fixed tripping delay
- Phase-loss detection with active motor
- Manual / Auto Reset selectable - 1sec or 5sec auto reset tripping delay

TYPE SELECTION :

SPECIFICATION :

Operating voltage	AC/DC(V): 100 - 240
Allowable operating voltage range	85~110% of rated operating voltage
Rated frequency	50 / 60 Hz
Detecting method	Detect 3-phase supply voltage
Detecting range	P TYPE: 77 ~ 143VAC L TYPE: 160 ~ 300VAC H TYPE: 277 ~ 519VAC
Reset time	1S / 5S
Display	Display resolution $\pm 1\%$
Contact rating	250VAC 5A (resistive load)
Power consumption	Approx. 3.3VA
Life	Mechanical: 5,000,000 times Electrical: 100,000 times
Ambient temperature	-10 ~ +50°C (without condensation & freezing)
Ambient humidity	MAX 85% RH (without condensation)
Altitude	MAX 2000m
Weight	Approx. 135g

Source type		3-Phase 3-Wire	3-Phase 4-Wire	1-Phase 2-Wire		DC voltage	
Output contact		1C		1C		1C	
Voltage detect range	P	UNDER 77-120V OVER 100-143V	AEVR-NP AEVR-YP	----	----	AEVR-NPS AEVR-NPSB AEVR-YPS AEVR-YPSB	AEVR-NPD AEVR-YPD
	L	UNDER 160-240V OVER 220-300V	AEVR-NL AEVR-YL	----	----	AEVR-NLS AEVR-NLSB AEVR-YLS AEVR-YLSB	AEVR-NLD AEVR-YLD
	H	UNDER 277-440V OVER 380-519V	AEVR-NH AEVR-YH	AEVR-N4 AEVR-Y4	AEVR-NHS AEVR-NHSB AEVR-YHS AEVR-YHSB	----	----

CONNECTION :

3 Phase 3 Wire

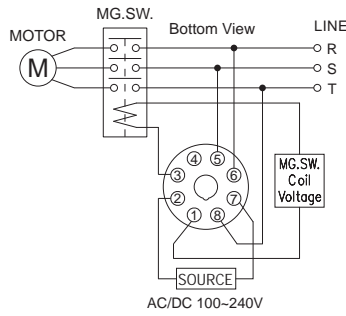

3 Phase 4 Wire

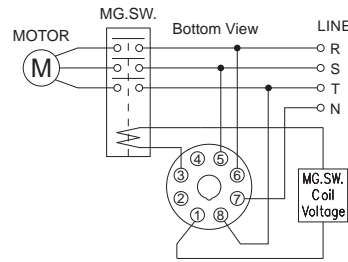

1 Phase 2 Wire

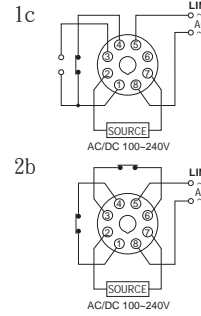

DC voltage

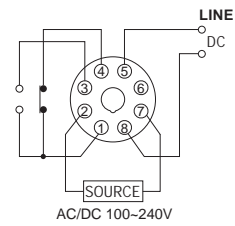

TIMING CHART :

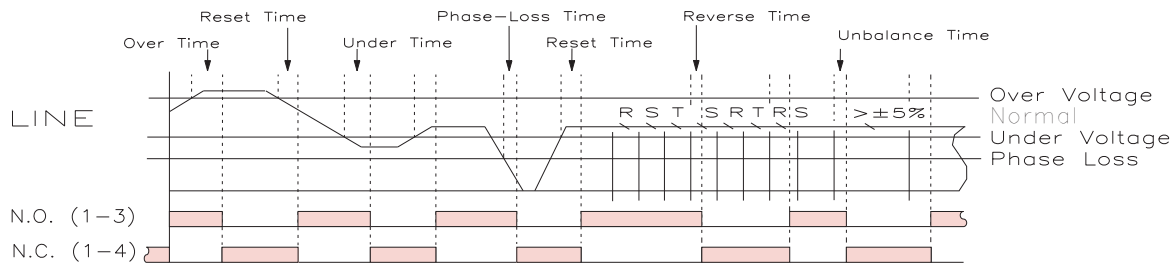

DIMENSIONS : (mm)

N type(Surface Mounting): Using 8PFA Socket

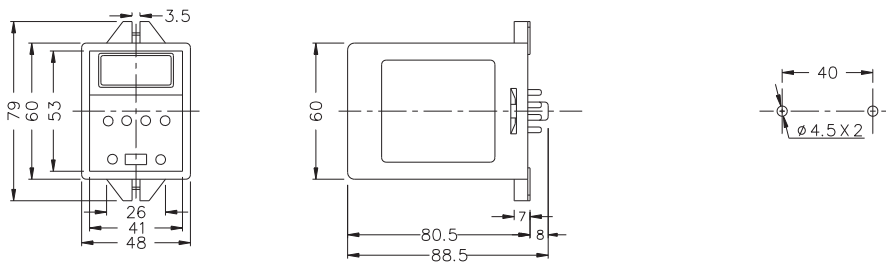

Y type(Flush Mounting): Using US-08 Socket or P3G-08 Socket

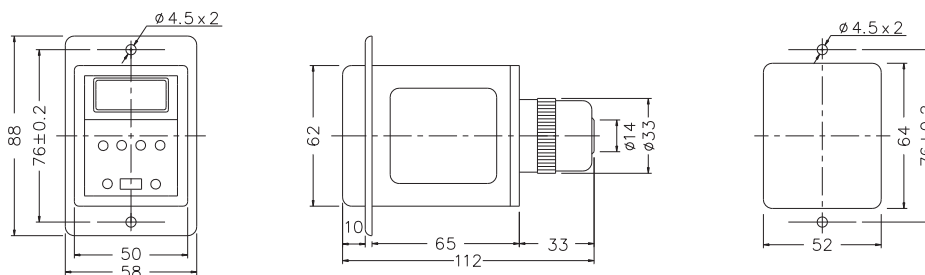

Tolerance:±0.1

ANLY ELECTRONICS CO., LTD.

<http://www.anly.com.tw>

TAIWAN MAIN OFFICE : ANLY ELECTRONICS CO., LTD.

No.19, Lane 202, Fushou St., Xinzhuang Dist., New Taipei City 242, Taiwan
TEL: +886-2-2996-3202 FAX: +886-2-2996-2017

MALAYSIA BRANCH : JUSTY ELECTRONICS (M) SDN, BHD.

No.1, Jalan 6/89B, Kawasan Perindustrian Trisegi, Batu 3 1/2 Off Jalan Sungei Besi, 57100 Kuala Lumpur, Malaysia
TEL: +60-3-7983-5758 FAX: +60-3-7981-5052

HONG KONG BRANCH : ANLY ELECTRONICS (HK) LTD.

Flat K, 13/F, Edward Mansion, 141 Prince Edward Road W., Kowloon, Hong Kong
TEL: +852-2397-2505 FAX: +852-2397-6080

SHANGHAI BRANCH : ANLY TECHNOLOGY (WUXI) CO., LTD.

Room 13G, No.831, Xinzha Rd., Jingan District, Shanghai, China 200041
TEL: +86-21-6218-3300 FAX: +86-21-6217-5911

NO. AEVR-R-B